

**STANLEY**<sup>®</sup>

Security Solutions



# 9K SERIES

HEAVY DUTY LOCKS - LEVERS



TABLE OF CONTENTS		Page	Page
Features .....	2	Function Descriptions .....	6-9
Specifications .....	3	Shipping Weights .....	9
How to Order .....	3	9K Sample Specifications .....	10
Trim Variations .....	4	Patented Keying .....	10
Options/Features .....	5	Deadlocking Latches .....	11
Service Equipment .....	5	Strikes & Door Preparation .....	11

**9K FEATURES**

For versatile applications, lever by knob trim variations are available.

Rose locking pin and rose assembly design offers great torque resistance. It prevents the locking pin from twisting, bending, or breaking under attack.

The innovative design of the slotted key release cam and locking lug assembly create maximum attack resistance. Amazingly, though damaged, the lock still allows key access. In addition, the lever is fully functional from the inside.

The hub-mounted torsion spring and strong retractor springs help prevent lever sag and offer a smooth and snappy operation.

Strong through-bolt mounting studs increase torque resistance. Heavy rose liner material is highly attack resistant.

Strong retractor springs provide resistance to lever sag.

The outside lever sleeve is a seamless one piece construction made of a hardened steel alloy that provides additional reinforcement in the locking lug slot.

Lost Motion feature available allowing lever movement between 45° – 60° without engaging retractor assembly.

No exposed keeper hole in exterior lever -adds security.

Interchangeable core allows for quick re-keying and customized masterkeying.

New zinc hubs with a shrouded locking lug, guaranteeing higher quality and increased torque resistance.

**Certifications— UL Listed:**  
Listed by Underwriter's Laboratories for use on 3 Hr, A label single swinging doors (4'x10'). GYJT Builders Hardware-single point locks or latches.



**American National Standard:** ANSI A156.2, Series 4000 Grade 1 (formerly FF-H-106C Series 161.)



American National Standards Institute  
11 West 42nd Street, New York, NY 10036



Finish—	BHMA	US	DESCRIPTION
	605	3	bright brass
	606	4	satin brass
	611	9	bright bronze
	612	10	satin bronze
	613	10B	oxidized satin bronze, oil rubbed
	618	14	bright nickel plated
	619	15	satin nickel plated
	622	19	flat black
	625	26	bright chromium plated
	626	26D	satin chromium plated
	690	20	dark bronze

**Backset—** 2 3/4" standard, 3 3/4" and 5" available.

**Chassis—** Critical latch and chassis components are brass or corrosion-treated steel. 2 1/16" diameter to fit 2 1/8" hole in door (Conforms to ANSI A115.2). Lost Motion feature available as an option.(see page 11 for special features)

**Door thickness—** Available for 1 3/4" to 2 1/4" doors. Spacers available for 1 3/8" doors.

**Latch—** Solid brass 9/16" throw. Front 2 1/4" x 1 1/8" beveled.

**Lever handles—** Lever handles are a high-quality zinc alloy. Trim components are brass or bronze. Body is approximately 1 5/8" in diameter; Handle is approximately 4 3/4" long (from center-line of chassis). #14 and #15 levers conform to California Administrative Code Title 19 and Title 24. All three styles of levers conform to the Illinois Accessibility Standard.

**Mounting—** In addition to standard door preparation (ANSI A115.2 for 1 3/4" doors), two additional holes are needed for through-bolts. Through-bolts require two 5/16" diameter holes located at 12 o'clock and 6 o'clock positions. A drill jig is provided to insure accuracy of the holes. (see KD303 on back page).

**Projection on door—** Approximately 2 3/4" when mounted on 1 3/4" door.

- Roses—**
- C - 3" Convex
  - D - 3 1/2" Convex
  - K - 3" Convex - no ring
  - L - 3 1/2" Convex - no ring

**Strike—** **STK:** Conforms to ANSI A115.2 (2 3/4" x 1 1/8" with curved lip & box). **S3:** Conforms to ANSI A115.2 for 1 3/4" doors (4 7/8" x 1 1/4" with curved lip). **S3-7/8:** Conforms to ANSI A115.2 for 1 3/4" doors (4 7/8" x 1 7/8" flat)

**Products protected by one or more of the following patents:**

U.S.:	Canada:
D290,085	4,437,695
4,428,212	4,428,212
4,843,852	4,318,558
4,428,570	4,428,570
4,262,507	4,496,178
4,779,908	4,779,908
5,116,170	1,229,358

Other products patent pending.

**HOW TO ORDER**

93K	7	AB	15	D	S3	626	Options
Backset	Core Housing	Function Code	Lever Style	Rose Style	Strike Package	Available Finishes*	
93K— 2 3/4"	0— keyless	AB— entrance	14— curved return	C— 3" convex	STK— 2 3/4"	605 606	AL— abrasive lever
94K— 3 3/4"	7— 7 pin housing accepts all Best cores	D— storeroom	15— contour angle return	D— 3 1/2" convex	ANSI	611 612	LL— lead lined
95K— 5"		L— privacy	16— curved no return	K— 3" convex - no ring	S3— 4 7/8"	613 618	LM— lost motion
		N— passage		L— 3 1/2" convex - no ring	ANSI	619 622	RQE— request to exit
		R— classroom			S3— 7/8-7/8" flat strike	625 626	SH— security head screws
		Etc.				690	TL— tactile lever
		pages 6-9	pages 4-5	pages 4-5	page 11		3/4-3/4" throw latch
							7/8" LTC— flat lip strike
							NOTE: specify inside (I), outside (O), or both (B) for AL, TL options
							page 5

\* Handles are made from a zinc alloy, and have been plated to be equivalent in appearance to the finishes listed. For information on 9K non IC products please refer to Best's non-IC keying products brochure.

TRIM VARIATIONS



14C



15C



16C



14D



15D



16D



14K



15K



16K



14L



15L



16L

LEVER & TRIM DIMENSIONS

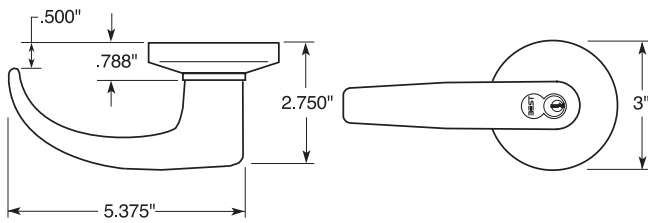

#14C or #14K Trim  
("C" rose shown)

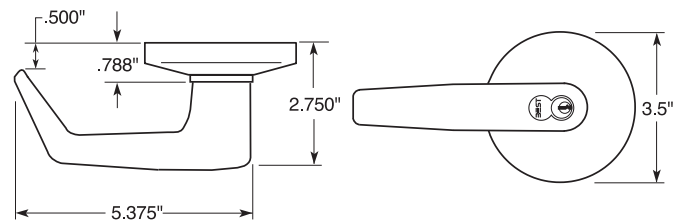

#15D or #15L Trim  
("D" rose shown)

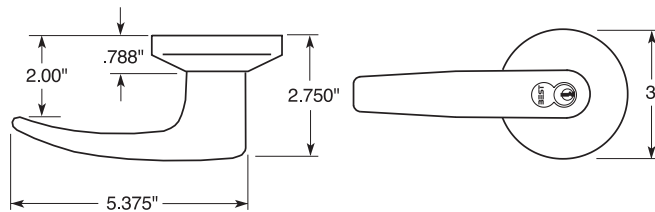

#16C or #16K Trim  
("K" rose shown)

## OPTIONS/FEATURES

### Abrasive Lever Option

Besides complying with a wide variety of accessibility codes and ordinances, Best Access Systems lever handles are available with a special abrasive feature. Abrasive strip on the lever immediately identifies warnings on doors to hazardous areas for the blind. **To order:** Designate "**AL**" on How to Order (page 3). **Note:** abrasive strip is available on all levers, except #14, #15, #16 levers in 613 finish.

### Lost Motion Feature

The Lost Motion feature allows the lever handle to move 45 degrees from parallel to the horizontal plane without engaging the latchbolt assembly. When the lockset is in the locked mode, this feature makes over-torque or over-lever-age abuse more difficult to achieve. **To order:** designate "**LM**" on How to Order (page 3).

### Non IC Lever Option

The 9K heavy duty cylindrical lock may be adapted to existing keying systems by using a special retrofit lever and throw member that will accept 6 pin single shear-line cylinders from non BEST manufacturers. No internal modifications are required to adapt the 9K to cylinders from the following manufacturers: Corbin-Russwin, Medeco, Sargent, Schlage, Yale. Refer to non-IC Best keying products brochure for more details.

### RQE Feature

The 9K lever handle cylindrical can be supplied with a request-to-exit (RQE) switch. A normally open switch provides momentary switch closure when the inside lever is rotated. **To order:** designate "**RQE**" on How to Order (page 3).

### Tactile Lever Option

Tactile levers may be used in areas where improved grip is required or as a warning in hazardous areas. Grooves are machined into the back of the hand grasp portion of the lever to improve grip and/or to provide a sensory warning in hazardous areas. This option can be used for Blind, Safety or Accessibility applications. **To order:** Designate "**TL**" on How to Order (page 3).

## SERVICE EQUIPMENT

### KD303 THROUGH-BOLT DRILL JIG



KD303-9K

Special accessory jig aids in aligning  $\frac{5}{16}$ " holes for through-bolt mounting. Install the latch first, then insert jig in  $2\frac{1}{8}$ " bored hole, align with door edge and drill with  $\frac{5}{16}$ " drill bit. A drill jig is included 1 per every 9 locksets with your order. Additional jigs are available upon request. **To order:** designate **KD303**.

### KD304A BORING JIG KITS



KD304A  
(Complete kit)

The **KD304A** jig kit is made for boring cut outs in wooden doors for ANSI A156.2 series cylindrical/tubular locksets, doors  $1\frac{3}{8}$ " to  $2\frac{1}{4}$ " thick. The **KD304A** kit includes the boring jig (to drill wood doors for  $2\frac{3}{8}$ ",  $2\frac{3}{4}$ ",  $3\frac{3}{4}$ " and 5" backsets), adaptor for  $\frac{3}{8}$ " drill chuck, **KD309:**  $2\frac{1}{8}$ " bit, **KD318:** 1" dia. x 9" bit, **KD312:** face plate marking chisel 1", **KD315:** face plate marking chisel  $1\frac{1}{8}$ ", and the **KD325:** strike plate locating pin. **To order:** complete kits specify **KD304A Kit**. All of the individual kit parts listed above may be ordered separately except for the adaptor chuck and jig.

### KD315 FACE PLATE MARKING CHISEL KD325 PLATE LOCATING PIN



KD315



KD325

The **KD315** faceplate marking chisel locates the mortising for the faceplate of ANSI A156.2 ( $1\frac{1}{8}$ " x  $2\frac{1}{4}$ ") cylindrical lockset. A strike plate locating pin **KD325** is available for use in conjunction with ANSI A156.2 cylindrical locksets.

**To order:** designate **KD312** faceplate marking chisel (1"), **KD315** faceplate marking chisel ( $1\frac{1}{8}$ "), **KD325** strike plate locating pin.

### KD317 SPANNER WRENCH KD340 SPRING TOOL



KD317  
Spanner Wrench



KD340  
Spring Tool



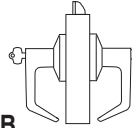
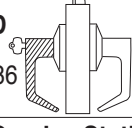
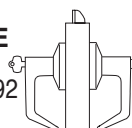
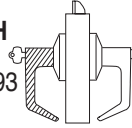
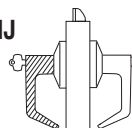
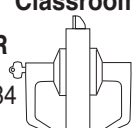
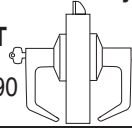
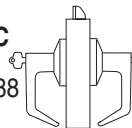
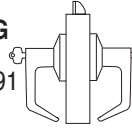

All 9K locksets require the use of **KD317** spanner wrench for door mounting. This tool is included 1 per every 9 locksets with your order. If more are needed, designate **KD317** on your order. The **KD340** lever return spring tool with its unique design feature is used when replacing the 9K lever return spring.

**To order:** designate **KD340**.

## FUNCTIONS

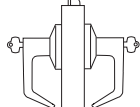
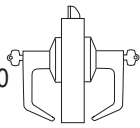
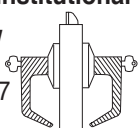
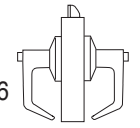
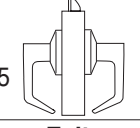
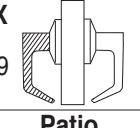
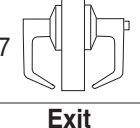
Function & Diag. (ANSI No.)	Description	Outside Lever		Inside Lever	
		Latched operated by	Locked by	Unlocked by	Locked by
<b>Single Keyed Functions</b>					
<b>Entrance</b>  AB F109	<ul style="list-style-type: none"> <li>Rotating the inside lever, <u>OR</u></li> <li>Rotating the outside lever—only when the inside push button is out, <u>OR</u></li> <li>Turning the key in the outside lever</li> </ul>	<ul style="list-style-type: none"> <li>Pushing the inside button, <u>OR</u></li> <li>Pushing and turning the inside button. Turning the button keeps the outside lever locked until the button is turned back</li> </ul>	<ul style="list-style-type: none"> <li>Turning the key in the outside lever, (only when the button is not turned) <u>OR</u></li> <li>Rotating the inside lever, (only when the button is not turned). <u>OR</u></li> <li>Closing the door (only when the button is not turned)</li> </ul>	Cannot be locked	Always unlocked
<b>Storeroom</b>  D F86	<ul style="list-style-type: none"> <li>Turning the key in the outside lever, <u>OR</u></li> <li>Rotating the inside lever</li> </ul>	Always fixed	Cannot be unlocked	Cannot be locked	Always unlocked
<b>Service Station</b>  E F92	<ul style="list-style-type: none"> <li>Rotating the inside lever, <u>OR</u></li> <li>Rotating the outside lever—only when the inside push button is out. <u>OR</u></li> <li>Turning the key in the outside lever</li> </ul>	<ul style="list-style-type: none"> <li>Pushing the inside button, <u>OR</u></li> <li>Pushing and turning the inside button. Turning the button keeps the outside lever locked until the button is turned back</li> </ul>	<ul style="list-style-type: none"> <li>Turning the key in the outside lever, <u>OR</u></li> <li>Rotating the inside lever, <u>OR</u></li> <li>Closing the door—only when the button is not turned, <u>OR</u></li> <li>Turning back the slotted button</li> </ul>	Cannot be locked	Always unlocked
<b>Hotel Guest Rm.</b>  H F93	<ul style="list-style-type: none"> <li>Rotating the inside lever, <u>OR</u></li> <li>Turning the key in the outside lever—only when the inside push button is out, <u>OR</u></li> <li>Removing the core with a control key and using a special emergency key</li> </ul>	Always fixed	<b>Key block feature is released by:</b> <ul style="list-style-type: none"> <li>Rotating the inside lever, <u>OR</u></li> <li>Closing the door</li> </ul>	Cannot be locked	Always unlocked
Pushing the inside button projects an “occupied” indicator in the outside lever and blocks all operating keys.					
<b>Hotel Guest Rm.</b>  HJ	<ul style="list-style-type: none"> <li>Rotating the inside lever, <u>OR</u></li> <li>Turning the key in the outside lever—only when the inside push button is out, <u>OR</u></li> <li>Removing the core with a control key and using a special emergency key</li> </ul>	Always fixed	<b>Key block feature is released by:</b> <ul style="list-style-type: none"> <li>Rotating the inside lever, <u>OR</u></li> <li>Closing the door</li> </ul>	Cannot be locked	Always unlocked
Pushing the inside button blocks all operating keys, but no “occupied” indicator is projected.					
<b>Classroom</b>  R F84	<ul style="list-style-type: none"> <li>Rotating the inside lever, <u>OR</u></li> <li>Turning the key in the outside lever, <u>OR</u></li> <li>Rotating the outside lever when not locked by key</li> </ul>	Turning the key in the outside lever	Turning the key in the outside lever	Cannot be locked	Always unlocked
<b>Dormitory</b>  T F90	<ul style="list-style-type: none"> <li>Rotating the inside lever, <u>OR</u></li> <li>Rotating the outside lever when not locked by key or push button</li> </ul>	<ul style="list-style-type: none"> <li>Turning the key in the outside lever, <u>OR</u></li> <li>Pushing the button on the inside lever</li> </ul>	<ul style="list-style-type: none"> <li>Turning the key in the outside lever, <u>OR</u></li> <li>Rotating the inside lever (only when locked by push button), <u>OR</u></li> <li>Closing the door (only when locked by push button)</li> </ul>	Cannot be locked	Always unlocked
<b>Double Keyed* Functions</b>					
<b>Corridor</b>  C F88	<ul style="list-style-type: none"> <li>Rotating the inside lever, <u>OR</u></li> <li>Rotating the outside lever when not locked by key, <u>OR</u></li> <li>Turning the key in the outside lever</li> </ul>	Turning the key in the inside lever	Turning the key in the inside lever	Cannot be locked	Always unlocked
<b>Storeroom *</b>  G F91	<ul style="list-style-type: none"> <li>Rotating the outside lever when not locked by key, <u>OR</u></li> <li>Rotating the inside lever when not locked by key</li> </ul>	<ul style="list-style-type: none"> <li>Turning the key in the inside lever, <u>OR</u></li> <li>Turning the key in the outside lever</li> </ul>	<ul style="list-style-type: none"> <li>Turning the key in the inside lever, <u>OR</u></li> <li>Turning the key in the outside lever</li> </ul>	<ul style="list-style-type: none"> <li>Turning the key in the inside lever, <u>OR</u></li> <li>Turning the key in the outside lever</li> </ul>	<ul style="list-style-type: none"> <li>Turning the key in the inside lever, <u>OR</u></li> <li>Turning the key in the outside lever</li> </ul>
Turning the key in either the inside or the outside, locks or unlocks both sides.					

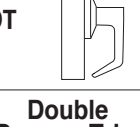
**\*ATTENTION:** Locksets that secure both sides of the door are controlled by building codes and the Life Safety Code. In an emergency exit situation, failure to quickly unlock the inside lever could be hazardous or even fatal.

Function & Diag. (ANSI No.)	Description	Outside Lever		Inside Lever	
		Latched operated by	Locked by	Unlocked by	Locked by
<b>Double Keyed Functions (Continued)</b>					
<b>Intruder</b> IN 	<ul style="list-style-type: none"> <li>Rotating inside lever, <u>OR</u></li> <li>Rotating outside lever only when not locked by inside or outside key</li> </ul>	<ul style="list-style-type: none"> <li>Turning key in the inside lever, <u>OR</u></li> <li>Turning the key in the outside lever</li> </ul>	<ul style="list-style-type: none"> <li>Turning key in the inside lever, <u>OR</u></li> <li>Turning the key in the outside lever</li> </ul>	Cannot be locked	Always unlocked
<b>Communicating*</b> S F80 	<ul style="list-style-type: none"> <li>Turning the key in the inside lever, <u>OR</u></li> <li>Turning the key in the outside lever, <u>OR</u></li> <li>Rotating the inside or outside lever (if unlocked)</li> </ul>	Turning the key in the outside lever	Turning the key in the outside lever	Turning the key in the inside lever	Turning the key in the inside lever
Turning the key in either lever, locks or unlocks its own lever independently.					
<b>Institutional*</b> W F87 	<ul style="list-style-type: none"> <li>Turning the key in the inside lever, <u>OR</u></li> <li>Turning the key in the outside lever</li> </ul>	Always fixed	Cannot be unlocked	Always fixed	Cannot be unlocked
<b>Keyless Functions</b>					
<b>Privacy</b> L F76 	<ul style="list-style-type: none"> <li>Rotating the inside lever <u>OR</u></li> <li>Rotating the outside lever only when the inside push button is out</li> </ul>	Pushing the inside button	<ul style="list-style-type: none"> <li>Rotating the outside slotted button, <u>OR</u></li> <li>Rotating the inside lever, <u>OR</u></li> <li>Closing the door.</li> </ul>	Cannot be locked	Always unlocked
<b>Passage</b> N F75 	<ul style="list-style-type: none"> <li>Rotating the inside lever, <u>OR</u></li> <li>Rotating the outside lever</li> </ul>	Cannot be locked	Always unlocked	Cannot be locked	Always unlocked
<b>Exit</b> NX F89 	Rotating the inside lever	Always fixed	Always fixed	Cannot be locked	Always unlocked
<b>Patio</b> P F77 	<ul style="list-style-type: none"> <li>Rotating the inside lever, <u>OR</u></li> <li>Rotating the outside lever only when the inside push button is out</li> </ul>	Pushing the inside button	<ul style="list-style-type: none"> <li>Rotating the inside lever, <u>OR</u></li> <li>Closing the door</li> </ul>	Cannot be locked	Always unlocked
<b>Exit</b> Y 	Rotating the inside lever			Cannot be locked	Always unlocked
<b>Single Dummy Trim</b> 1DT 	This is a single, surface-mounted lever for an inactive door or a non-latching door				
<b>Double Dummy Trim</b> 2DT 	This is a through bolt mounted pair of matching levers for an inactive door or a non-latching door				

**\*ATTENTION:** Locksets that secure both sides of the door are controlled by building codes and the Life Safety Code. In an emergency exit situation, failure to quickly unlock the inside lever could be hazardous or even fatal.

## FUNCTIONS

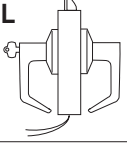
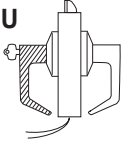
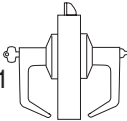
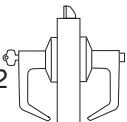
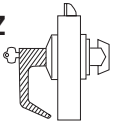
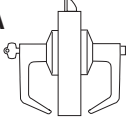
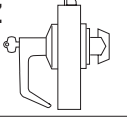
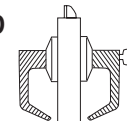
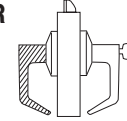
Function & Diag. (ANSI No.)	Description	Outside Lever		Inside Lever	
		Latch operated by	Locked by	Unlocked by	Locked by
<b>Electromechanical Functions</b>					
<b>Electrically Locked</b> <b>DEL</b> 	<ul style="list-style-type: none"> <li>Rotating the inside lever, <b>OR</b></li> <li>Rotating the outside lever only when power is off, <b>OR</b></li> <li>Turning the key in the outside lever</li> </ul>	<ul style="list-style-type: none"> <li>Applying 24 Volts DC.</li> <li>Outside lever remains locked only while power is on</li> </ul>	Switching off 24 Volts DC	Cannot be locked	Always unlocked
<b>Electrically Unlocked</b> <b>DEU</b> 	<ul style="list-style-type: none"> <li>Rotating the inside lever, <b>OR</b></li> <li>Rotating the outside lever only when power is on, <b>OR</b></li> <li>Turning the key in the outside lever</li> </ul>	Switching off 24 Volts DC	<ul style="list-style-type: none"> <li>Applying 24 Volts DC</li> <li>Outside lever remains unlocked only while power is on</li> </ul>	Cannot be locked	Always unlocked
<b>Special Functions</b>					
<b>Dormitory or Storeroom</b> <b>A</b> <b>F81</b> 	<ul style="list-style-type: none"> <li>Rotating the inside lever, <b>OR</b></li> <li>Rotating the outside lever only when inside turn button is in unlocked position, <b>OR</b></li> <li>Turning the key in the outside lever</li> </ul>	Turning the inside button	Turning the inside button	Cannot be locked	Always unlocked
<b>NOTE:</b> Turn button must be manually rotated to unlock the outside lever.					
<b>Office</b> <b>B</b> <b>F82</b> 	<ul style="list-style-type: none"> <li>Rotating the inside lever, <b>OR</b></li> <li>Rotating the outside lever only when inside push button is out, <b>OR</b></li> <li>Turning the key in the outside lever</li> </ul>	Pushing the inside button	<ul style="list-style-type: none"> <li>Turning the key in the outside lever, <b>OR</b></li> <li>Rotating the inside lever</li> </ul>	Cannot be locked	Always unlocked
<b>NOTE:</b> Push button is released by turning the key in the outside lever, <b>OR</b> rotating the inside lever. Closing the door does not release the push button.					
<b>Closet or Storeroom</b> <b>DZ</b> 	<ul style="list-style-type: none"> <li>Turning the key in the outside lever, <b>OR</b></li> <li>Turning the inside closet turn knob</li> </ul>	Always fixed	Cannot be unlocked	Closet turn knob cannot be locked	Closet turn knob always free
<b>Entrance or Office</b> <b>EA</b> 	<ul style="list-style-type: none"> <li>Rotating the inside lever, <b>OR</b></li> <li>Rotating the outside lever only when inside push button is out, <b>OR</b></li> <li>Turning the key in the outside lever</li> </ul>	<ul style="list-style-type: none"> <li>Pushing the inside button, <b>OR</b></li> <li>Pushing and turning the inside button. Turning the slotted button keeps the outside lever locked until the button is turned back</li> </ul>	<ul style="list-style-type: none"> <li>Turning the key in the outside lever, <b>OR</b></li> <li>Rotating the inside lever, <b>OR</b></li> <li>Turning the slotted button back</li> </ul>	Cannot be locked	Always unlocked
<b>Closet or Storeroom</b> <b>RZ</b> 	<ul style="list-style-type: none"> <li>Turning the key in the outside lever, <b>OR</b></li> <li>Turning the inside closet turn knob, <b>OR</b></li> <li>Rotating the outside lever when not locked by key</li> </ul>	Turning the key in the outside lever	Turning the key in the outside lever	Closet turn knob cannot be locked	Closet turn knob always free
<b>Special*</b> <b>XD</b> 	Turning the key in the inside lever	Always fixed	Cannot be unlocked	Always fixed	Cannot be unlocked
<b>Special*</b> <b>XR</b> 	<ul style="list-style-type: none"> <li>Turning the key in the inside lever, <b>OR</b></li> <li>Rotating the inside lever when not locked by key</li> </ul>	Always fixed	Cannot be unlocked	Turning the key in the inside lever	Turning the key in the inside lever

**\*ATTENTION:** Locksets that secure both sides of the door are controlled by building codes and the Life Safety Code. In an emergency exit situation, failure to quickly unlock the inside lever could be hazardous or even fatal.

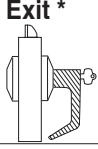
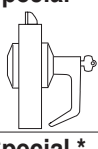
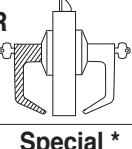
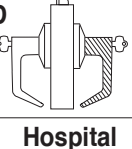
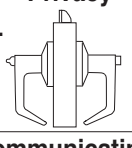
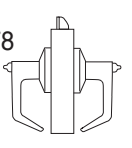
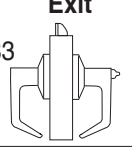
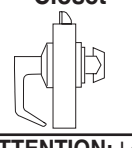

**FUNCTIONS**

Function & Diag. (ANSI No.)	Description	Outside Lever		Inside Lever	
		Latched by	Locked by	Unlocked by	Locked by
<b>Special Functions (Continued)</b>					
YD 	<b>Exit *</b> Turning the key in the inside lever				Always fixed Cannot be unlocked
YR 	<b>Special *</b> • Turning the key in the inside lever, <u>OR</u> • Rotating the inside lever when not locked by key				Turning the key in the inside lever Turning the key in the inside lever
DR 	<b>Special *</b> • Rotating the inside lever only when not locked by key, <u>OR</u> • Turning the key in the outside lever, <u>OR</u> • Turning the key in the inside lever	Always fixed	Cannot be unlocked		Turning the key in the inside lever Turning the key in the inside lever
RD 	<b>Special *</b> • Rotating the outside lever only when not locked by key, <u>OR</u> • Turning the key in the outside lever, <u>OR</u> • Turning the key in the inside lever	Turning the key in the outside lever	Turning the key in the outside lever		Always fixed Cannot be unlocked
LL 	<b>Hospital Privacy</b> • Rotating the inside lever, <u>OR</u> • Rotating the outside lever only when the inside push button is out	Pushing the inside push button	• Turning the turn button in the outside lever, <u>OR</u> • Rotating the inside lever, <u>OR</u> • Closing the door		Cannot be locked Always unlocked
M F78 	<b>Communicating*</b> • Rotating the inside lever-only when the outside turn button is in the unlocked position, <u>OR</u> • Rotating the outside lever-only when the inside turn button is in the unlocked position	Turning the inside turn button	Turning the inside turn button	Turning the outside turn button	Turning the outside turn button
<b>NOTE:</b> Do not use this function for rooms that have no other entrance.					
Q F83 	<b>Exit</b> • Rotating the inside lever, <u>OR</u> • Rotating the outside lever-only when the inside turn button is in the unlocked position	Turning the inside turn button	Turning the inside turn button		Cannot be locked Always unlocked
Z 	<b>Closet</b> • Rotating the outside lever, <u>OR</u> • Turning the inside closet turn knob	Cannot be locked	Always unlocked	Closet turn knob cannot be locked	Closet turn knob is always free

**\*ATTENTION:** Locksets that secure both sides of the door are controlled by building codes and the Life Safety Code. In an emergency exit situation, failure to quickly unlock the inside lever could be hazardous or even fatal.

**SHIPPING WEIGHTS**

The chart is the approximate shipping weight for the standard 9K functions locksets. This weight includes the weight of the lockset with the “#15” style lever, “K” style rose, latch, strike package, and box. Listed separately are the approximate weights for “with core” and “less core” shipments.

LOCK FUNCTION NOMENCLATURE	CASE QUANTITY	SHIPPING WEIGHT-WITH CORE	SHIPPING WEIGHT-LESS CORE
Y	9		31 lbs.
N	9		40 lbs.
L,NX,P	9		40 lbs.
AB,D,E,H,HJ,R,T	9	42lbs.	40 lbs.
C,G,IN,S,W	9	44 lbs.	40 lbs.

## ACCEPTABLE MANUFACTURERS

### A. Locksets and Latchsets

Best Access Systems - No Substitution.

1. Locksets must be extra heavy-duty cylindrical type with 2 <sup>3</sup>/<sub>4</sub> inch backset, or greater as specified, with a <sup>9</sup>/<sub>16</sub> inch throw latchbolt.
2. Provide locksets with Best 7-pin interchangeable core.
3. Locksets and latchsets must conform to ANSI A156.2, Series 4000, Grade 1, and be UL listed.
4. Locksets and cores to be of the same manufacturer to maintain complete lockset warranty.
5. Locksets must be available with tactile or abrasive lever for identification of hazardous areas.
6. Locks to have solid shank with no opening for access to keyed lever keeper.
7. Keyed lever to be removable only after core is removed, by authorized control key, to allow access to lever "keeper".
8. Permanent core face must be the same finish as the lockset finish.
9. Levers must have a minimum wall thickness of .060.

### B. Keys and Keying

- A. Provide construction cores and keys during the construction period. Construction, control and operating keys and cores shall not be part of the Owner's permanent keying system or furnished on the same keyway as the Owner's permanent keying system. Permanent cores and keys prepared according to the accepted keying schedule will be furnished to the Owner by the local Best Access Systems office prior to occupancy. The Owner or Owner's agent will install permanent cores and return the construction cores to the Best Access Systems office.
- B. All cylinders shall be Best 7-pin, interchangeable core and keyed into a [new] [existing] factory registered Grand Master Key System with a restricted keyway.
- C. Permanent keys and cores shall be stamped with the applicable key mark for identification. These visual key control marks or codes will **not** include the actual key cuts. Permanent keys will also be stamped ["Do Not Duplicate".] ["U.S. Gov.-Do Not Duplicate".] [ \_\_\_\_\_ .]
- D. Grand Masterkeys, Masterkeys and other Security Keys shall be transmitted to the Owner by U.P.S., delivery confirmation requested.
- E. Furnish keys in the following quantities:
  - 1 each Grand Masterkey
  - 2 each Masterkeys per set
  - 1 each Change key per each keyed core
  - 2 each Construction masterkeys
  - 2 each Control keys
- F. Computer key and core control software Best Access System Keystone® 600 will be provided and registered to the owner by the local Best Access Systems office. The owner will furnish compatible hardware to operate the key and core control program. The Best Access Systems office will provide initial training on computer key and core control as well as on-going support including software updates.

## PATENTED KEYING



**BEST Peaks®** – For advanced solutions in key control and security, BEST offers Peaks®, the most adaptable and cost effective patented keying system on the market. The patented mechanism ensures that cylinders and cores will only operate with the Peaks® keys, which are only available through authorized BEST distributors.

For BEST products, Peaks® offers the security and convenience of a patented solution for interchangeable core. Peaks® is also available to adapt to a wide variety of locks from other manufacturers. All cylinders can be keyed into the same system, providing you the ability to operate all the locks at your facility using a single key, regardless of the lock manufacturer.

## DEADLOCKING LATCHES



### 8KL3 Deadlocking Latch

**Bolt throw**— $\frac{9}{16}$ "  
**Backset**— $2\frac{3}{4}$ "  
**Front**— $2\frac{1}{4}$ " x  $1\frac{1}{8}$ " beveled.  
**Tube**— To fit 1" diameter hole in door edge.  
**To order:** (with unit) designate "93K" on How to Order (page 3).  
**To order:** (without unit) designate "8KL3-SL" (Spring Latch) or DL (Deadlocking Latch) and finish.



### 8KL4 Deadlocking Latch

**Bolt throw**— $\frac{9}{16}$ "  
**Backset**— $3\frac{3}{4}$ "  
**Front**— $2\frac{1}{4}$ " x  $1\frac{1}{8}$ " beveled.  
**Tube**— To fit 1" diameter hole in door edge.  
**To order:** (with unit) designate "94K" on How to Order (page 3).  
**To order:** (without unit) designate "8KL4-SL" (Spring Latch) or DL (Deadlocking Latch) and finish.



### 8KL5 Deadlocking Latch

**Bolt throw**— $\frac{9}{16}$ "  
**Backset**— 5"  
**Front**— $2\frac{1}{4}$ " x  $1\frac{1}{8}$ " beveled.  
**Tube**— To fit 1" diameter hole in door edge.  
**To order:** (with unit) designate "95K" on How to Order (page 3).  
**To order:** (without unit) designate "8KL5-SL" (Spring Latch) or DL (Deadlocking Latch) and finish.

## STRIKES



8KS3-7/8

### 8KS3-7/8 Flat Strike

**Dimension:** Conforms to ANSI A115.2 for  $1\frac{3}{4}$ " doors ( $4\frac{7}{8}$ " x  $1\frac{7}{8}$ " flat)  
**To order:** (with unit) designate "S3-7/8" on How to Order (page 3).  
**To order:** (without unit) designate 8KS3-7/8 and finish.



8KS3

### 8KS3 Strike

**Dimension:** Conforms to ANSI A115.2 for  $1\frac{3}{4}$ " doors ( $4\frac{7}{8}$ " x  $1\frac{1}{8}$ " with curved lip).  
**To order:** (with unit) designate "S3" on How to Order (page 3).  
**To order:** (without unit) designate 8KS3 and finish.



8KS2

### 8KS2 Strike (Supplied Standard)

**Dimension:** Conforms to ANSI A115.2 for  $1\frac{3}{8}$ " doors ( $2\frac{3}{4}$ " x  $1\frac{1}{8}$ " with curved lip and box).  
**To order:** (with unit) designate "STK" on How to Order (page 3).  
**To order:** (without unit) designate 8KS2 and finish.

## STRIKES & DOOR PREPARATION

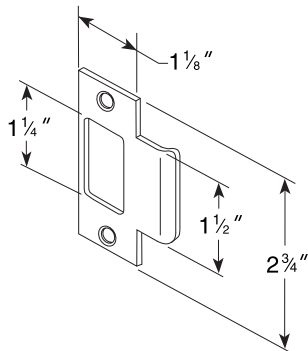

STK strike (standard)

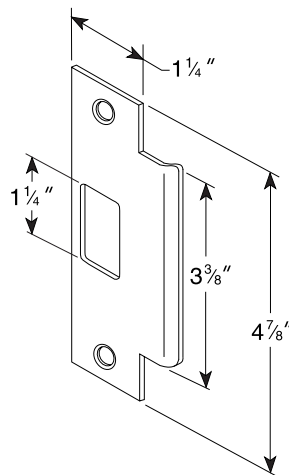

S3 strike

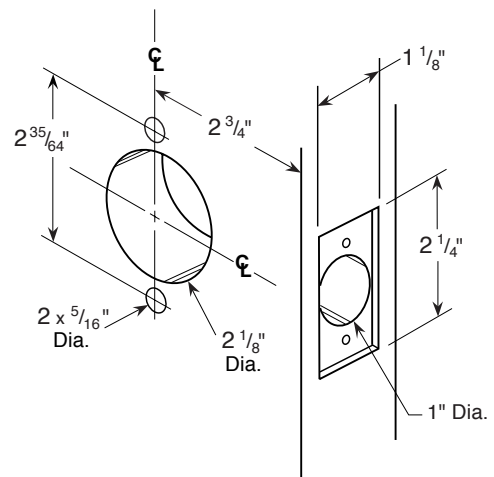

9K door preparation with through-bolt mountings

DEADLOCKING LATCHES

STRIKES

STRIKES & DOOR PREP.



### Best Access Systems

A Division of Stanley Security Solutions, Inc.  
6161 E. 75th Street Indianapolis, Indiana 46250  
[www.bestaccess.com](http://www.bestaccess.com)

For more information on BEST's full line of security solutions visit our web site at [www.stanleysecuritysolutions.com](http://www.stanleysecuritysolutions.com) or call 1-317-849-2250 for the name of the Stanley Security Solutions office nearest you.

Product information contained in this catalog has been compiled and presented with as much care and completeness as is reasonably possible. Errors or mistakes may be present, and in many cases, reliance has been placed on information supplied by other manufacturers which may be in error or which may be subject to changes or modifications by the manufacturer without notice and without obligation. Therefore, no guarantee can be made or should be assumed or implied with regards to product information contained in this catalog.

**Product Warranty** – Best Access Systems warrants that all of its products sold under its trade name "BEST" are free of defects in materials, workmanship and operation, normal wear and tear excepted, for a period of **three years** from the date of sale to the original purchaser.

**Concerning Proper Installation:** Installation instructions for any Best Access Systems product should be carefully followed for proper operation of the installed product. If improperly installed, malfunction of the product may result.



Security Solutions

### Stanley Security Solutions, Inc.

6161 E. 75th Street Indianapolis, Indiana 46250  
[www.stanleysecuritysolutions.com](http://www.stanleysecuritysolutions.com)